

# HARVIA VEGA

HCB450400S

*The stainless steel outer shell of Vega is durable and creates a modern look for your sauna. The operating switches are placed ergonomically in the upper part, and thanks to the symmetric shape of the heater, the switches can be placed on either side.*



## Features

Main material : Steel

H x W x D : 540.0 x 480.0 x 310.0 mm

Net weight (kg) : 11.0

Installation location : Wall

ID	GTIN	Output (kW)	Sauna room size min - max m <sup>3</sup>
HCB450400S	6410082608041	4.5 kW	3.0-6.0

## Related products

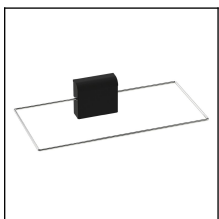

SFE-220400

## Spare parts

Product	ID	Pcs
Variant 1505*1505 sauna cabin	S1515	
Variant 1505*1505 right sauna cabin	S1515R	
Variant 1505*1505 left sauna cabin	S1515L	
Variant 1505*1505 sauna cabin	S1515	
Variant 1505*1505 right sauna cabin	S1515R	
Variant 1505*1505 left sauna cabin	S1515L	

## Technical details

Technical data	Type / attribute	HC B450400S
	Color	Stainless Steel
	Power output	4.5 kW
	Stone sizes	Ø5–10 cm
	Stone amount (kg)	20
Dimensions	Product width	480
	Product height	540
	Product depth (mm)	310
	Net weight (kg)	11
	Gross weight	12.4
	Package width	315
	Package height	475
	Package depth	500
Safety and installation dimensions	Safety distance front (combustible materials)	20
	Safety distance right side (combustible materials)	20
	Safety distance left side (combustible materials)	20
	safety distance to the side wall (combustible materials)	50
	Safety distance (Ceiling)	1100
	Room min. height(depends on connections and therefore from output, star/delta)	1900
	Installation opening height	1900
	Installation opening width	550
	Installation opening depth	340

Technical images

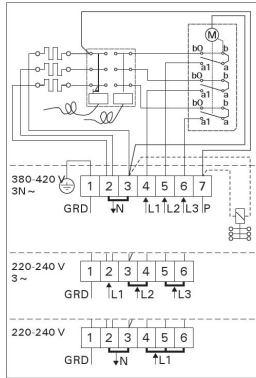

Electrical connections of BC heater  
Elektroanschlüsse des Saunaofens BC

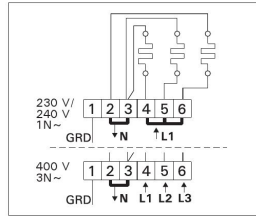

Electrical connections of BC-E heater  
Elektroanschlüsse des Saunaofens BC-E

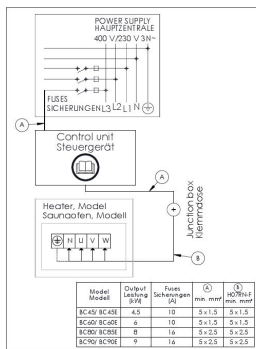

Model Modell	Control Leuchte S/N	Phase Schwinger Ø	Ø mm	Ø mm	Ø mm
BC45/BC45E	4,5	10	5 x 1,5	5 x 1,5	
BC60/BC60E	6	10	5 x 1,5	5 x 1,5	
BC80/BC80E	8	16	5 x 2,5	5 x 2,5	
BC90/BC90E	9	16	5 x 2,5	5 x 2,5	

3-phase electrical connections of control  
unit C150 and BC-E heater  
3-phaseser Elektroanschlüsse des  
Steuergerät C150 und des Saunaofens BC-E

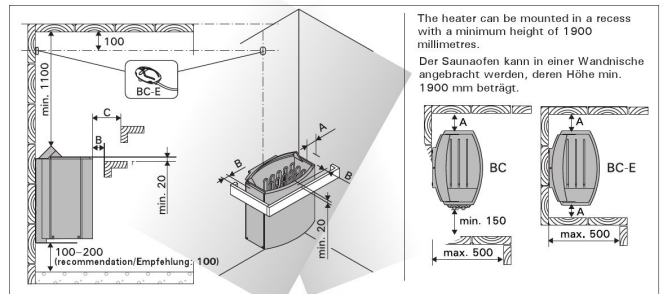

The heater can be mounted in a recess with a minimum height of 1900 millimetres.  
Der Saunaofen kann in einer Wandnische angebracht werden, deren Höhe min. 1900 mm beträgt.

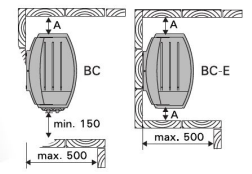

	A min. from side to wall, upper platform or rail von der Seitenfläche zur Wand, zur oberen Bank oder zum oberen Geländer	B min.	C min. from front surface to upper platform or rail von der Vorderfläche zur oberen Bank oder zum oberen Geländer
BC45/BC45E	35	20	35
BC60/BC60E	50	30	50
BC80/BC80E	100	30	80
BC90/BC90E	120	40	100

	SSTL/EGFF	
1	ZSB-224	8266392 1500 W/230 V
2	ZSB-226	8266393 2000 W/230 V
3	ZSB-228	8266394 2670 W/230 V
4	ZSB-229	8266395 3000 W/230 V
5	ZSK-510	8260996
6	ZSB-125	°C (BC)
7	ZSK-520	8260997
8	ZSB-115	°C (BC)
9	ZSB-200	

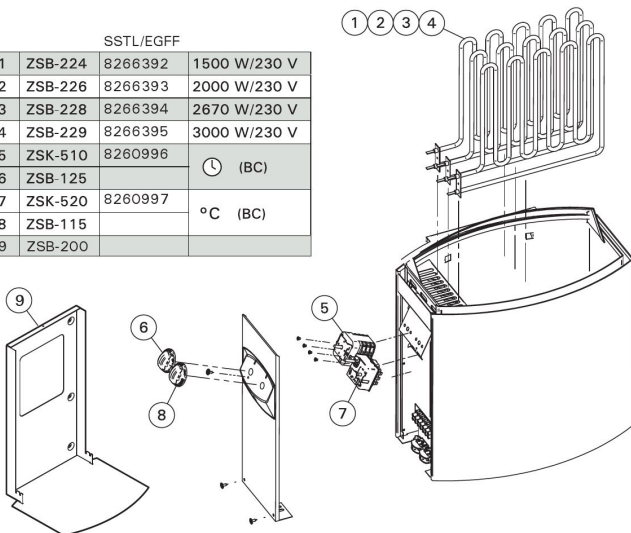

We recommend to use only the manufacturer's spare parts.  
Es dürfen ausschließlich die Ersatzteile des Herstellers verwendet werden.